

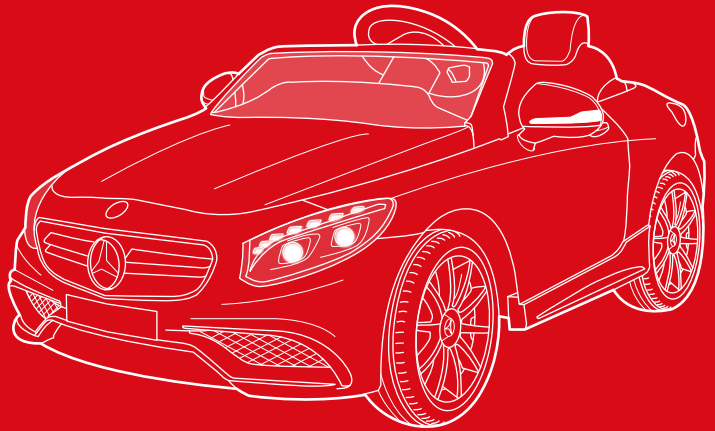

bestchoiceproducts



# INSTRUCTION MANUAL

---

Mercedes S63 Ride-On  
with Remote Control



bestchoiceproducts

---

As shoppers, we're always trying to find the perfect balance between quality & value. At BCP, we believe we've achieved that. Our diverse catalog of everyday essentials is tailored especially to our customers & guaranteed to hit that sweet spot of high quality & low price.

— Always. —



Charge for **12 hrs**  
before initial use.

After initial charge,  
follow the normal  
recommended  
charging time.



## SAFETY

Please retain these instructions for future reference.

This vehicle must be assembled by an adult who has read and understood the instructions in this manual. Keep the packaging and bags away from children and dispose of all packaging before use. Always use common sense and safe practices when operating this vehicle. This product contains or emits chemicals known in the state of California to cause cancer or birth defects or other reproductive harm.

**NOTE:** For best performance, only use this vehicle on flat and hard surfaces.

**AGE RANGE:** 2 to 6 years old

**WEIGHT CAPACITY:** 77 lbs.

The following safety hazards may result in serious injury or death:

- This product contains small parts. Keep children away during assembly. Make sure to remove all packaging material and parts from underneath the vehicle body.
- Never open the battery. Batteries contain lead and lead compounds (acids) that are toxic and corrosive, and known to the state of California to cause cancer and reproductive harm.
- Limbs, hair, and clothing can get caught in moving parts. Always wear shoes, keep limbs away from moving parts, and do not wear loose clothing while operating this vehicle.
- This vehicle does not have brakes or braking capability. Do not leave a child unattended during operation. Do not use this in a location that may require braking capability, as this could result in loss of control, which may cause serious injury or death.
- Use of this vehicle near streets, motor vehicles, steps, bodies of water, sloped surfaces, hills, wet areas, flammable vapors, in alleys, at night, or in the dark could result in an unexpected accident.
- Use of this vehicle in unsafe conditions such as snow, rain, loose dirt, mud, sand, or gravel may result in an unexpected accident such as tipping over, and could damage the electrical system or battery.
- Do not operate this vehicle in an unsafe manner. Examples include but are not limited to:
  - Pulling the vehicle with another vehicle or similar device
  - Allowing more than one rider
  - Pushing the user
  - Traveling at an unsafe speed

## BATTERY WARNINGS

The following safety hazards may result in serious injury or death:

- Use of a battery or charger other than the supplied rechargeable battery and charger may cause a fire or explosion. Only use the supplied battery and charger.
- Use of the rechargeable battery and charger for any other product may result in overheating, fire, or explosion. Never use the supplied rechargeable battery and charger with another product.
- Explosive gases are created during charging. Charge the battery in a well-ventilated area. Do not charge the battery near heat or flammable materials.
- Contact between the positive and negative terminals may result in fire or explosion. Avoid direct contact between the terminals. Picking up the battery by the wires or charger can cause damage to the battery and may result in a fire. Always pick up the battery by its case or handles.
- Liquids on the battery may cause fire or electric shock. Always keep all liquids away from the battery and keep the battery dry. Contact or exposure to battery leakage (lead acid) may cause serious injury. If contact or exposure occurs immediately call your physician. If the chemical is on the skin or in the eyes, flush with cool water for 15 minutes. If the chemical was swallowed, immediately give the person water or milk. Do not give water or milk if the patient is vomiting or has a decreased level of alertness. Do not induce vomiting.
- Battery posts, terminals, and related accessories contain lead and lead compounds (acid) - chemicals known to the State of California to cause cancer, reproductive harm, and are toxic and corrosive. Never open the battery.
- Tampering or modifying the electric circuit system may cause a shock, fire or explosion and permanently damage the system. Exposed wiring and circuitry in the charger may cause electric shock. Always keep the charger housing closed.

## USER WARNINGS

To reduce the risk of injury, adult supervision is required. Never use on roadways, near motor vehicles, on or near steep inclines or steps, swimming pools or other bodies of water; always wear shoes, and never allow more than one child in the vehicle at a time.

- Only one child is allowed in the vehicle at a time.
- Never leave a child unattended.
- Always sit in the seat when using this vehicle.
- Keep your hands, hair, and clothes away from moving parts.
- Children under 2 years of age cannot use the vehicle.
- Only drive on level ground.
- Do not drive the vehicle into loose dirt, mud, sand, fine gravel, or on wet surfaces.

## SPECIFICATIONS

<b>Overall Dimensions</b>	44"(L) x 22.5"(W) x 20"(H)
<b>Weight</b>	44 lbs.
<b>Weight Capacity</b>	77 lbs.
<b>Age Range</b>	2 - 6 years old
<b>Max Speed</b>	4 mph.
<b>Initial Charge Time</b>	12 hours
<b>Charging Time</b>	8 - 10 hours
<b>Run Time</b>	1 hour
<b>Battery Type</b>	Rechargeable SLA - 12V 7AH
<b>Electric Motor</b>	Double drive: 12V
<b>Charger</b>	Output: DC 12V
<b>Material</b>	PP Plastic, Metal

## TOOLS



PHILLIPS  
SCREWDRIVER



NEEDLE NOSE  
PLIER



WRENCH



2 AAA BATTERIES



2 PEOPLE  
ASSEMBLY



APPROXIMATELY  
45 MIN.  
ASSEMBLY

## HARDWARE

Spare parts may be included

### 1 COTTER PIN



4 PCS

### 2 WASHER



6 PCS

### 3 5x38mm BOLT

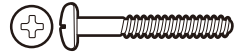

1 PC

### 4 4x12mm SCREW



3 PC

### 5 5mm NUT



1 PC

## PARTS

### A FRONT WHEEL

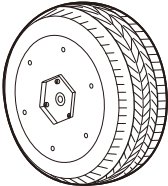

2 PCS

### B REAR WHEEL

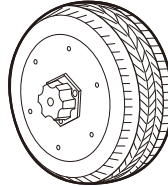

2 PCS

### C HUB CAP

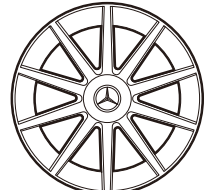

4 PCS

## PARTS

**D** STEERING WHEEL

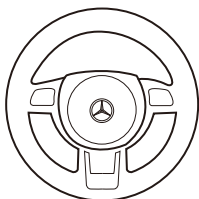

1 PC

**E** WINDSHIELD

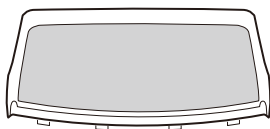

1 PC

**F** LEFT MIRROR



1 PC

**G** RIGHT MIRROR



2 PCS

**H** SEAT

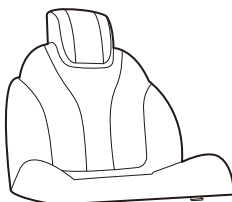

1 PC

**I** REMOTE

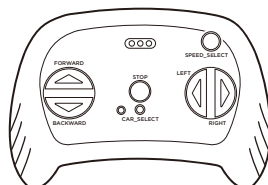

1 PC

**J** 6V/12V CHARGER

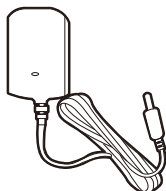

2 PCS

**K** AUX CORD



1 PC

# PRODUCT ASSEMBLY

1



Use needle nose pliers to bend the cotter pin and lock the wheel in place.

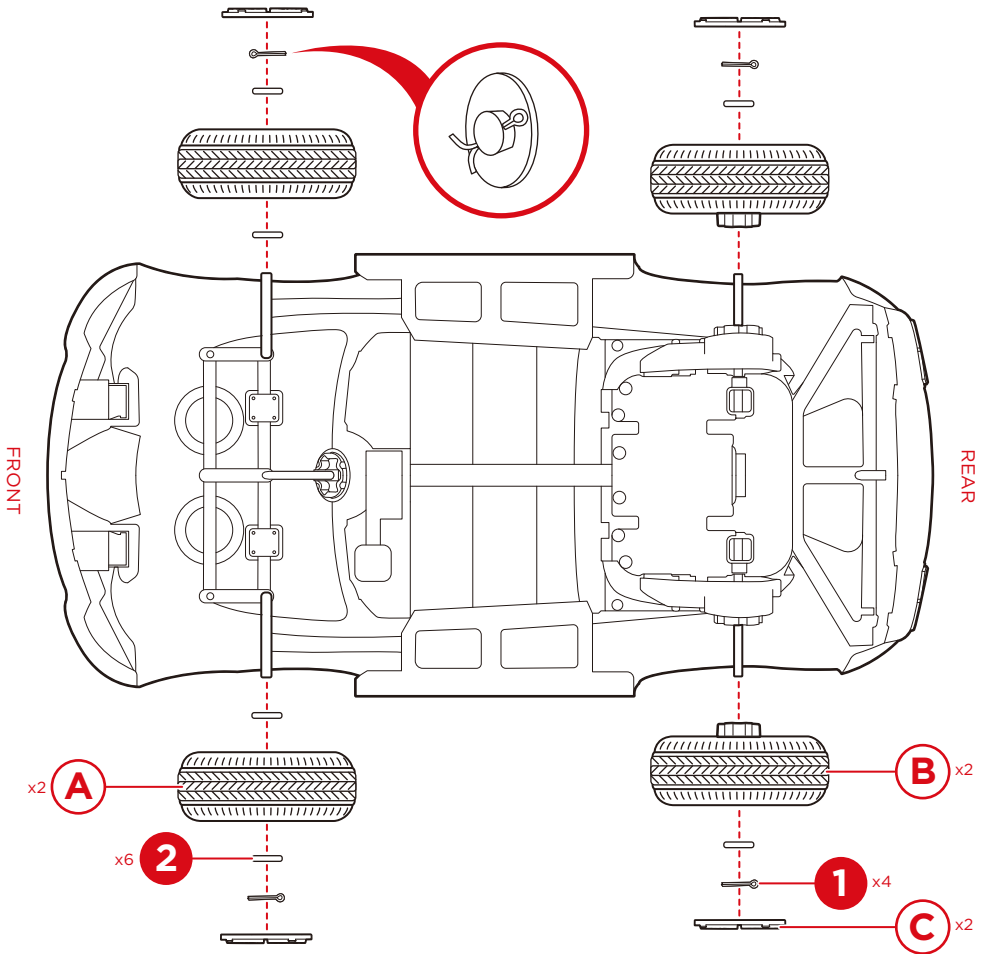

Remove four part 1 cotter pins from the front and rear axles.

Slide a part 2 washer and part A front wheel onto the front axle, then secure it with another part 2 washer and cotter pin. Repeat on the other side. Snap a part C hub cap onto each wheel.

Slide a part B rear wheel onto the rear axle and secure it with a part 2 washer and cotter pin. Repeat on the other side. Snap a part C hub cap onto each wheel.



## PRODUCT ASSEMBLY

2

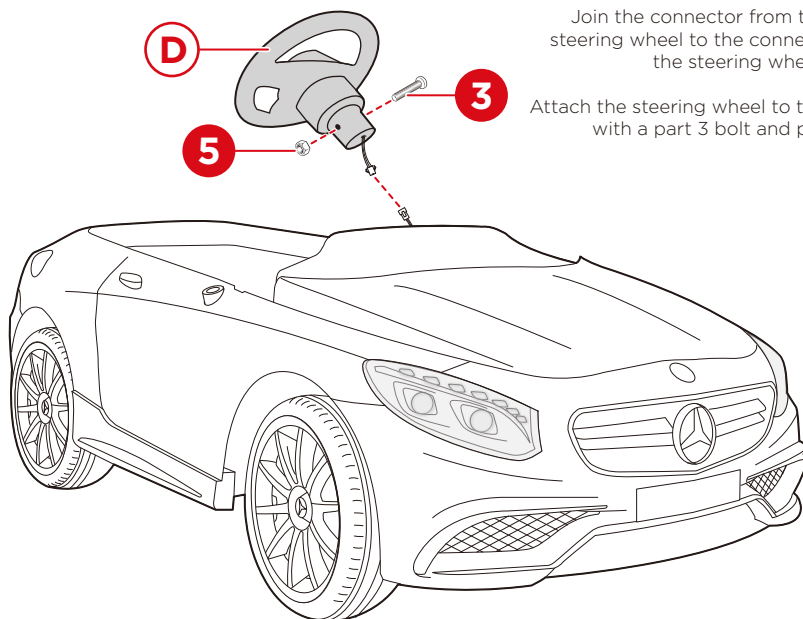

3

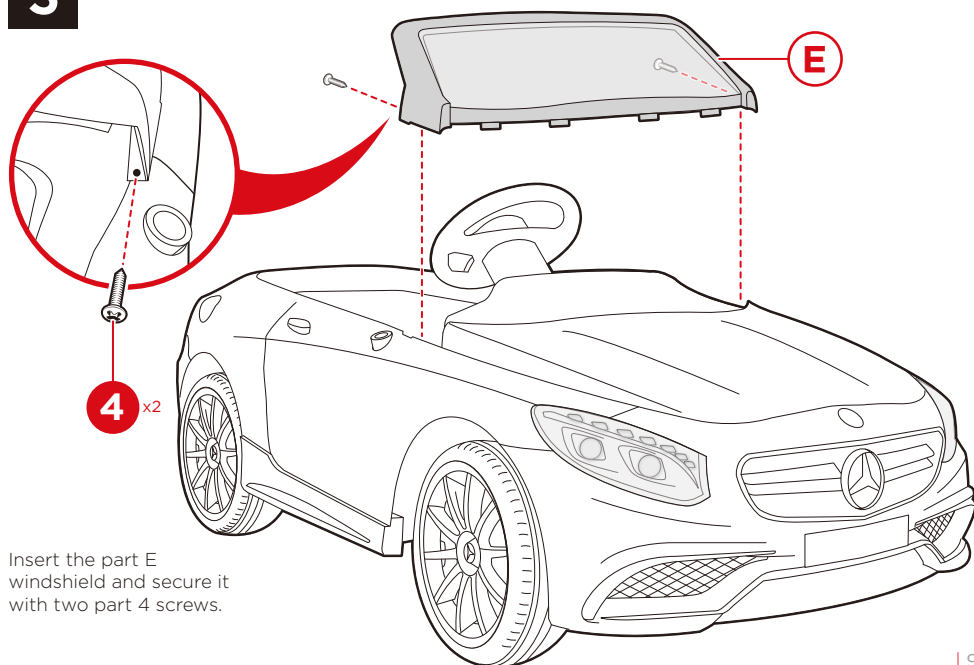

## PRODUCT ASSEMBLY

4

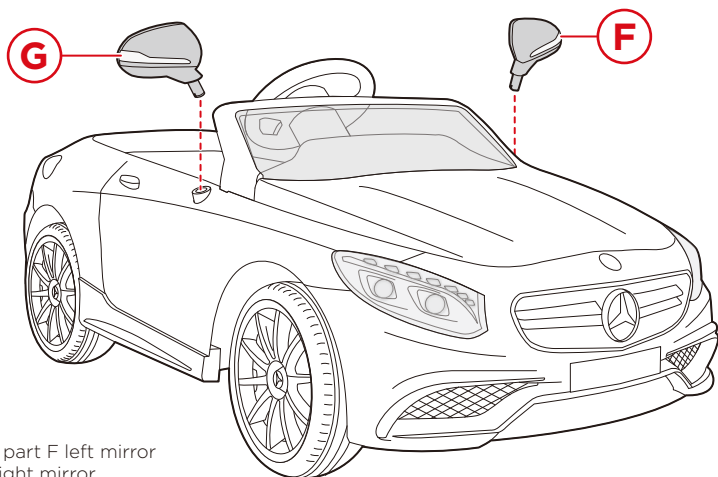

Snap on the part F left mirror and part G right mirror.

5

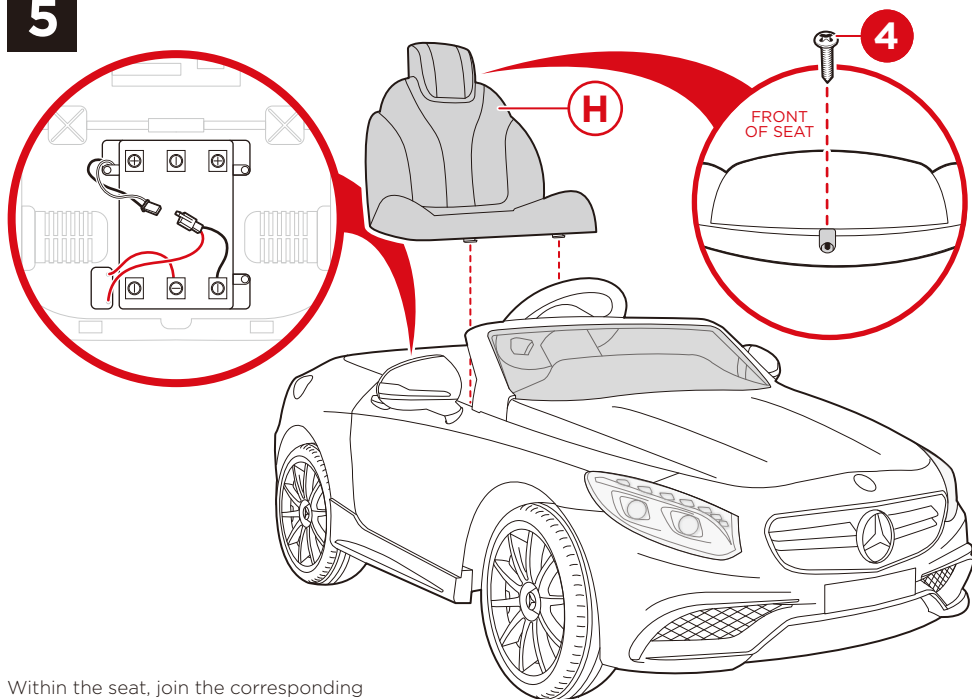

Within the seat, join the corresponding battery connectors together.

Install the part H seat and secure it with a part 4 screw.

## CHARGING INSTRUCTIONS AND DIAGRAM

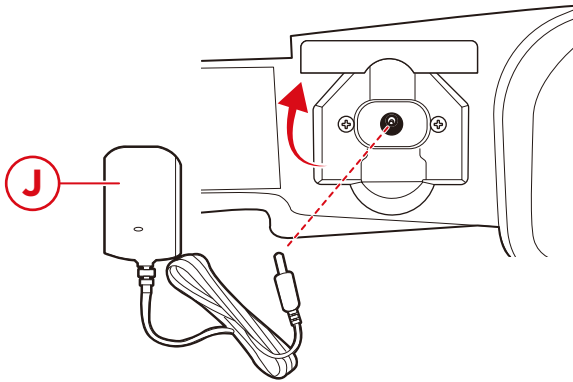

- Charging socket is located on the dashboard (see Dashboard Diagram). Lift the cover, insert one end of the part J charger into the charging socket and plug the other end into a wall outlet.
- Charge the battery at least 12 hours before initial use.
- On average, you will need to charge the battery between 8 and 10 hours. Do not charge the battery for more than 24 hours. Failure to charge the battery as directed could cause permanent damage to the battery and void the warranty.
- Damage to the battery may occur if it is allowed to drain completely. Do not allow the battery to drain completely.
- Check the battery and charger (supply cord, connector) for wear and damage before charging. Do not charge the battery if damage has occurred.
- Only an adult who has read and understood the safety warnings should handle, charge and recharge the battery.

## CARING FOR YOUR RIDE-ON

- Park the vehicle indoors or cover it with a tarp to protect it from wet weather.
- Do not leave the vehicle in the sun for long periods of time or fading may occur. Store in shade or cover with tarp.
- Do not wash the vehicle with a hose.
- Do not wash the vehicle with soap.
- Charge battery at least once a month to prolong the life of the battery.

## DASHBOARD DIAGRAM

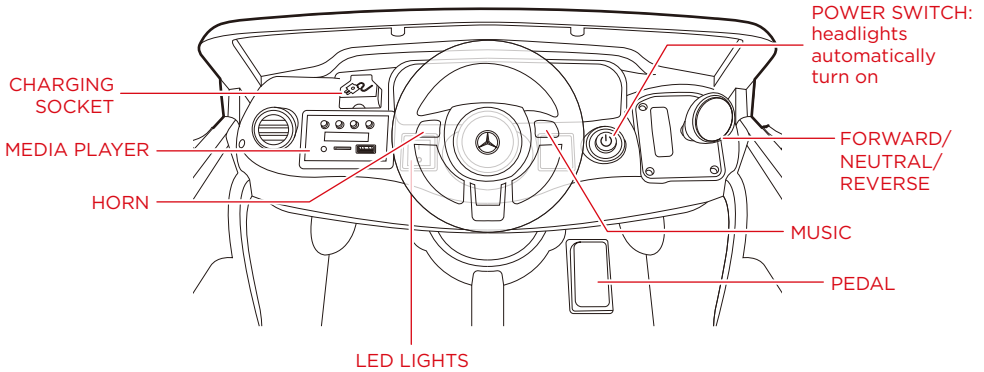

- Push down on the pedal to drive forward/reverse. Release the pedal to slow down and stop.

## MEDIA PLAYER

- **AUX input:** Plug in a music player to play music
- **MicroSD (TF) port:** Play music from a MicroSD card
- **USB port:** Play music from a USB drive
- **Previous / - :** Short press to play the previous song, long press to decrease volume
- **Next / +:** Short press to play to the next song, long press to increase volume
- **Pause/Play:** Play or pause music
- **Mode:** Press to toggle between AUX, MicroSD, and USB music modes

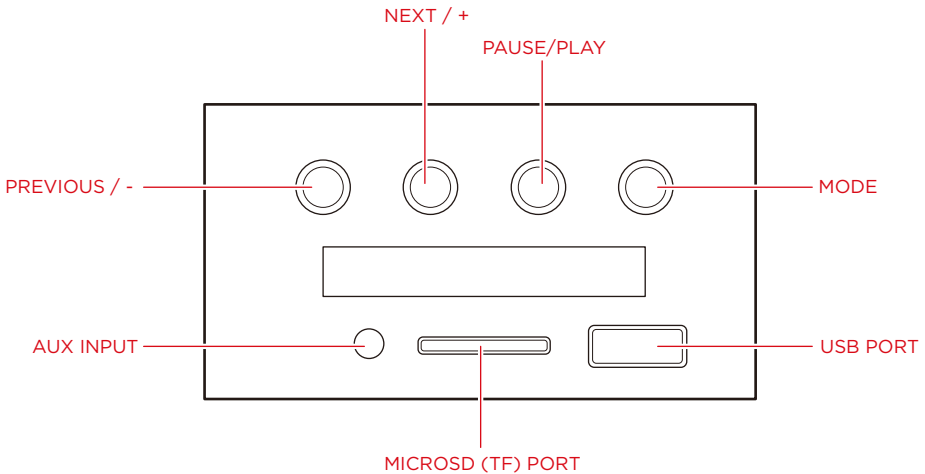

## REMOTE CONTROL FUNCTIONS

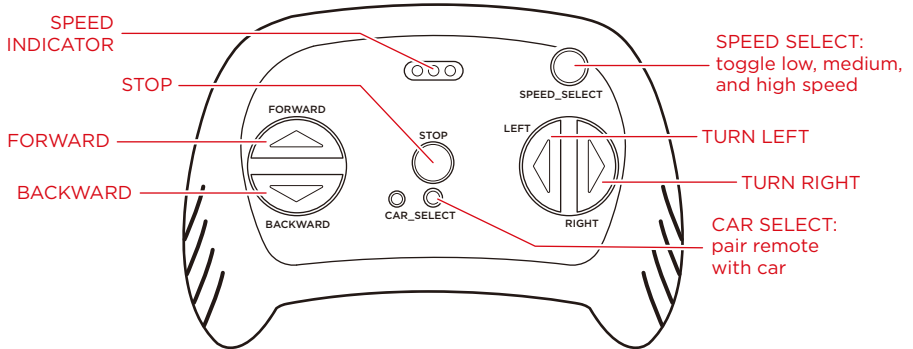

- Insert 2 AAA batteries into the remote control.
- After 15 seconds of non-operation, the remote will go into power-saving mode.

### Linking the remote control:

1. Press and hold the car select button for 2 seconds. The car select light will flash.
2. Turn the vehicle on. The car select light will turn off to indicate a successful link.
3. If the car select light continues to flash (indicating an unsuccessful link), repeat steps 1 and 2.

## TROUBLESHOOTING

Problem	Reason	Solution
Vehicle does not move	Low battery	Fully charge the battery
	Electrical protection	Stop use for several minutes and restart
	Switch not in the correct position	Completely press in switches
	Battery connectors disconnected	Plug in battery connectors
Battery does not recharge	Battery connectors disconnected	Plug in battery connectors
	Charger not connected to socket or outlet	Completely plug in the charger
Battery does not last	Battery does not have a full charge	Fully charge the battery
Battery is warm and makes a slight noise while charging	Normal	Normal
Slow speed	Low battery	Fully charge the battery
	Overloaded vehicle	Reduce the weight on the vehicle
	Uneven or sloped road	Drive on flat pavement
Vehicles shakes while driving	Loose connection to motor	Ensure the motor is properly connected to the battery
Vehicle is silent	Steering wheel is not properly connected	Properly connect the steering wheel connector

## WARNINGS REGARDING BATTERIES

- Do not mix alkaline, standard (carbon zinc) and rechargeable (nickel hydride) batteries.
- Do not mix old and new batteries.
- Non-rechargeable batteries should not be charged.
- Rechargeable batteries should be charged under adult supervision only.
- Exhausted batteries should be removed.
- The supply terminals should not be short-circuited.
- Do not put batteries next to or in a heat source (fire, electronic heating device, etc.).
- Do not hit batteries against hard objects.
- Do not submerge batteries in water.
- Batteries should be inserted with the correct polarity.

## CALIFORNIA PROPOSITION 65

 **WARNING:** Battery posts, terminals, and related accessories can expose you to chemicals including lead and lead compounds, which are known to the State of California to cause cancer and birth defects or other reproductive harm, and are toxic and corrosive. Wash hands after handling. For more information go to [www.P65Warnings.ca.gov](http://www.P65Warnings.ca.gov)

## FCC COMPLIANCE STATEMENT

This device complies with part 15 of the FCC rules. Operation is subject to the following two conditions: (1) This product may not cause harmful interference, and (2) this device must accept any interference received, including interference that may cause undesired operation.

NOTE: This equipment has been tested and found to comply with the limits for a Class B digital device, pursuant to part 15 of the FCC Rules. These limits are designed to provide reasonable protection against harmful interference in a residential installation.

This equipment generates, uses, and can radiate radio frequency energy and, if not installed and used in accordance with the instructions, may cause harmful interference to radio communications. However, there is no guarantee that interference will not occur in a particular installation.

If this equipment does cause harmful interference to radio or television reception, which can be determined by turning the equipment off and on, the user is encouraged to try to correct the interference by one or more of the following measures:

- Reorient or relocate the receiving antenna.
- Increase the separation between the equipment and receiver.
- Connect the equipment to an outlet on a circuit different from that to which the receiver is connected.
- Consult the dealer or an experienced radio/TV technician for help.

WARNING: Any changes or modifications to this unit not expressly approved by the party responsible for compliance could void the user's authority to operate the equipment.

*Responsible party (contact for FCC matters only):*

Quality Control Dept.  
5642 Ontario Mills Parkway  
Ontario, CA 91764

Earn points while you shop. Join today!

bestchoiceproducts  
**rewards**

Join | Earn | Redeem

Give your friends 15% off their first order! For each successful referral you'll receive 100 points.

[bestchoiceproducts.com](https://bestchoiceproducts.com)



# HELP CENTER



Question about your product? We're here to help. Visit us at:

[help.bestchoiceproducts.com](http://help.bestchoiceproducts.com)



Chat Support



Product Inquiry



Orders FAQ



Product Assembly



Returns & Refunds

## PRODUCT WARRANTY INFORMATION

All items can be returned for any reason within 60 days of the receipt and will receive a full refund as long as the item is returned in its original product packaging and all accessories from its original shipment are included. All returned items will receive a full refund back to the original payment method. All returned items will not be charged a re-stocking fee.

All returned items require an RA (Return Authorization) number, which can only be provided by a Best Choice Products Customer Service Representative when the return request is submitted. Items received without an RA may not be accepted or may increase your return processing time. Once an item has been received by Best Choice Products, refunds or replacements will be processed within 5 business days.

All returns must be shipped back to the Best Choice Products Return Center at the customer's expense. If the reason for return is a result of an error by Best Choice Products then Best Choice Products will provide a pre-paid shipping label via email. Boxes for return shipping will not be provided by Best Choice Products, and is the customer's responsibility to either use the original shipping boxes or purchase new boxes.

Pictures may be required for some returns to ensure an item is not damaged prior to its return. Items returned are not considered undamaged until they are received by Best Choice Products and verified as such. All damages to items are the customer's responsibility until the item has been received by and acknowledge by Best Choice Products as undamaged.

## WARNING

Manufacturer and seller expressly disclaim any and all liability for personal injury, property damage or loss, whether direct, indirect, or incidental, resulting from the incorrect attachment, improper use, inadequate maintenance, or neglect of this product.