

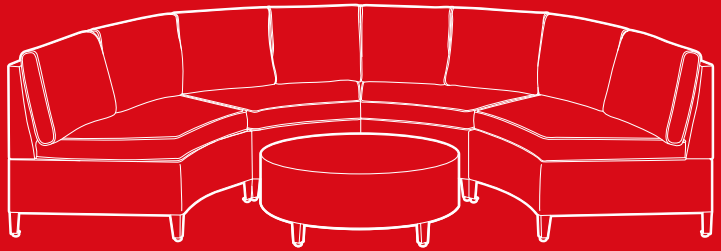

bestchoiceproducts



INSTRUCTION MANUAL

5-Piece Wicker Sectional



bestchoiceproducts

Thank you for choosing us! Since 2002, Best Choice Products has been bringing customers high-quality products at the absolute lowest price. With everything ranging from instruments and toys to furniture and outdoor, we've got your everyday living essentials covered. We're centered around a customer-first philosophy - with free shipping, exceptional customer service, and a catalog sourced with you in mind.

! NOTICE

Please retain these instructions for future reference.

- Please do not exceed the weight limitations of this item.
- Do not stand on or use any part of this item as a step ladder.
- Firmly secure all bolts, screws and knobs before use.
- Reconfirm that all bolts, screws, and knobs are secure every 90 days.
- Fasten screws loosely during initial assembly. Do not firmly tighten the screws until the item is completely assembled.
- Do not use or store this item in the proximity of open flame or flammable/combustible chemicals.
- Be aware that some parts are heavy and have sharp edges.
- If any parts are missing, broken, damaged, or worn, stop using this product until repairs are made and/or factory replacement parts are installed.
- Do not use this item in a way inconsistent with the manufacturer's instructions as this could void the product warranty.

TOOLS REQUIRED



ALLEN WRENCH
(PROVIDED)



CHAIR
330 LBS
CAPACITY



TABLE
165 LBS
CAPACITY



1 PERSON
ASSEMBLY



APPROXIMATELY
60 MIN.
ASSEMBLY

HARDWARE

1

M6x40mm SCREW

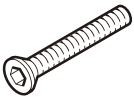

20 PCS

2

WASHER



20 PCS

PARTS

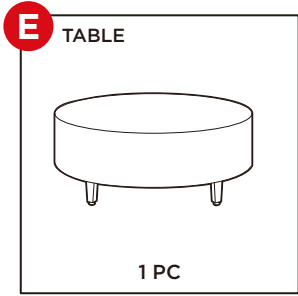
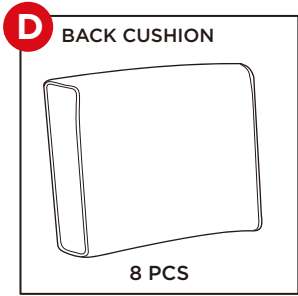
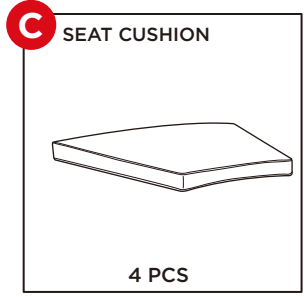
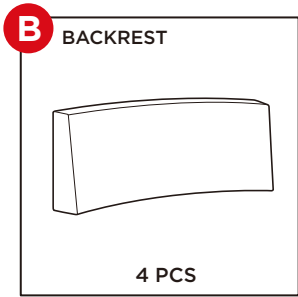
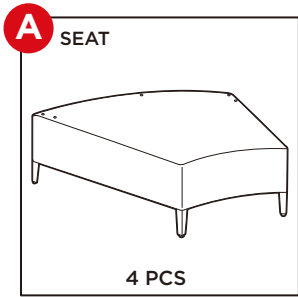

PRODUCT ASSEMBLY

1

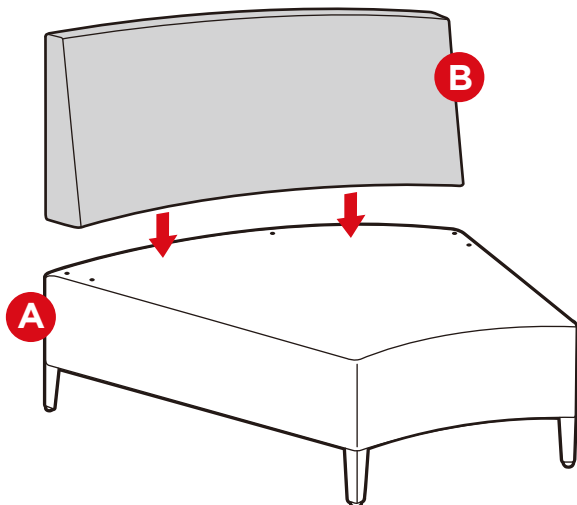

2

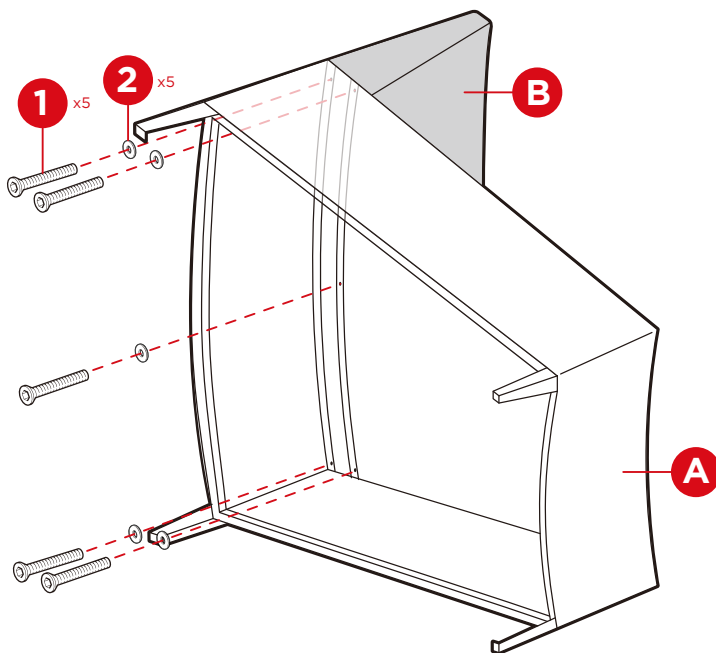

Attach the part A seat to the part B backrest with five part 1 screws and five part 2 washers.

PRODUCT ASSEMBLY

3

Place a part C seat cushion and two part D back cushions.

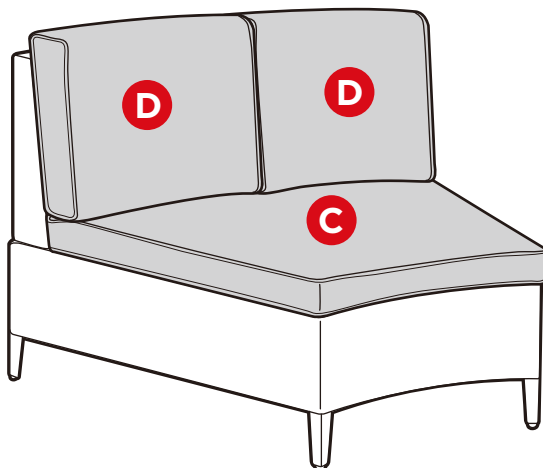

Repeat steps 1 to 3 to build additional chairs.

4

Arrange the chairs into a sectional and place the part E table.

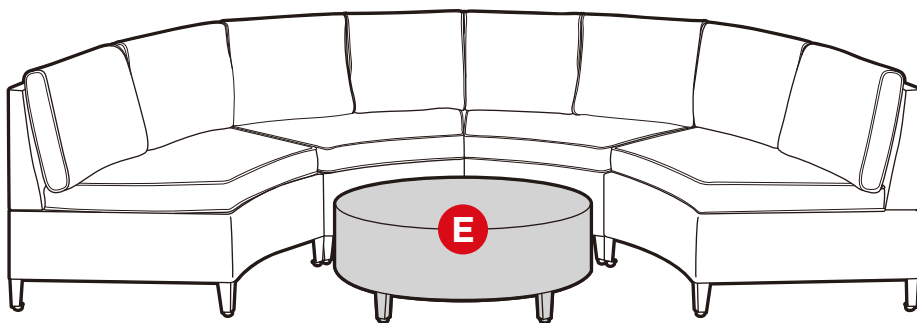



bestchoiceproducts

Check out more great products:
[bestchoiceproducts.com](https://www.bestchoiceproducts.com)

ENJOY YOUR PRODUCT!

bcp

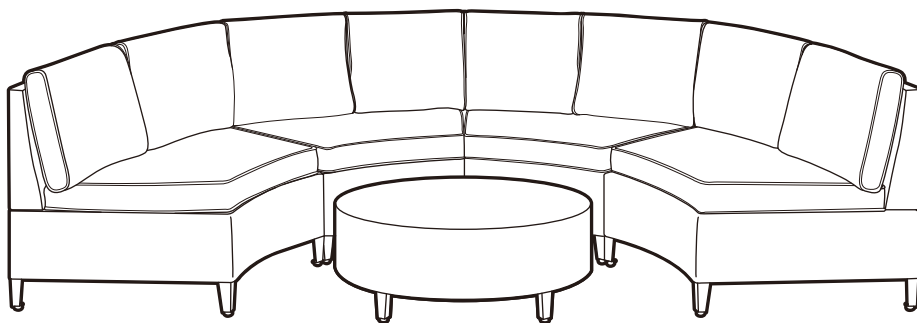

PRODUCT WARRANTY INFORMATION

All items can be returned for any reason within 60 days of the receipt and will receive a full refund as long as the item is returned in its original product packaging and all accessories from its original shipment are included. All returned items will receive a full refund back to the original payment method. All returned items will not be charged a re-stocking fee.

All returned items require an RA (Return Authorization) number, which can only be provided by a Best Choice Products Customer Service Representative when the return request is submitted. Items received without an RA may not be accepted or may increase your return processing time. Once an item has been received by Best Choice Products, refunds or replacements will be processed within 5 business days.

All returns must be shipped back to the Best Choice Products Return Center at the customer's expense. If the reason for return is a result of an error by Best Choice Products then Best Choice Products will provide a pre-paid shipping label via email. Boxes for return shipping will not be provided by Best Choice Products, and is the customer's responsibility to either use the original shipping boxes or purchase new boxes.

Pictures may be required for some returns to ensure an item is not damaged prior to its return. Items returned are not considered undamaged until they are received by Best Choice Products and verified as such. All damages to items are the customer's responsibility until the item has been received by and acknowledge by Best Choice Products as undamaged.

CONTACT US; WE'RE HERE 7 DAYS A WEEK TO HELP YOU!



bestchoiceproducts.com



customerservice@bestchoiceproducts.com



844.948.8400



[LEARN MORE!](#)

⚠️ WARNING

Manufacturer and seller expressly disclaim any and all liability for personal injury, property damage or loss, whether direct, indirect, or incidental, resulting from the incorrect attachment, improper use, inadequate maintenance, or neglect of this product.