



bestchoiceproducts



INSTRUCTION MANUAL

Oversized Zero Gravity Chair

Ver. 2

SKY4502 + SKY4503 + SKY4504 + SKY4505 + SKY4506 + SKY4507 + SKY4508

PARTS

A

ACCESSORY TRAY

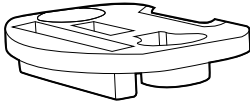

1 PC



250 LBS
CAPACITY



1 PERSON
ASSEMBLY



APPROXIMATELY
5 MIN.
ASSEMBLY

PRODUCT ASSEMBLY

Please retain these instructions for future reference.

1

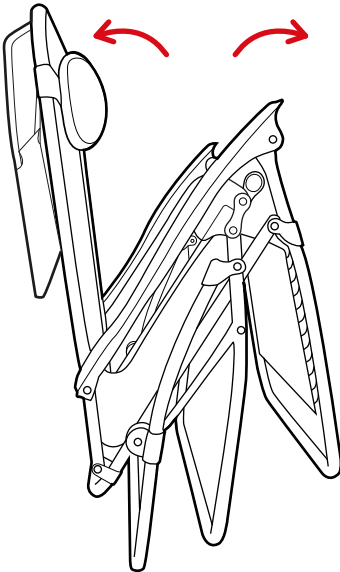

2



PRODUCT ASSEMBLY

3

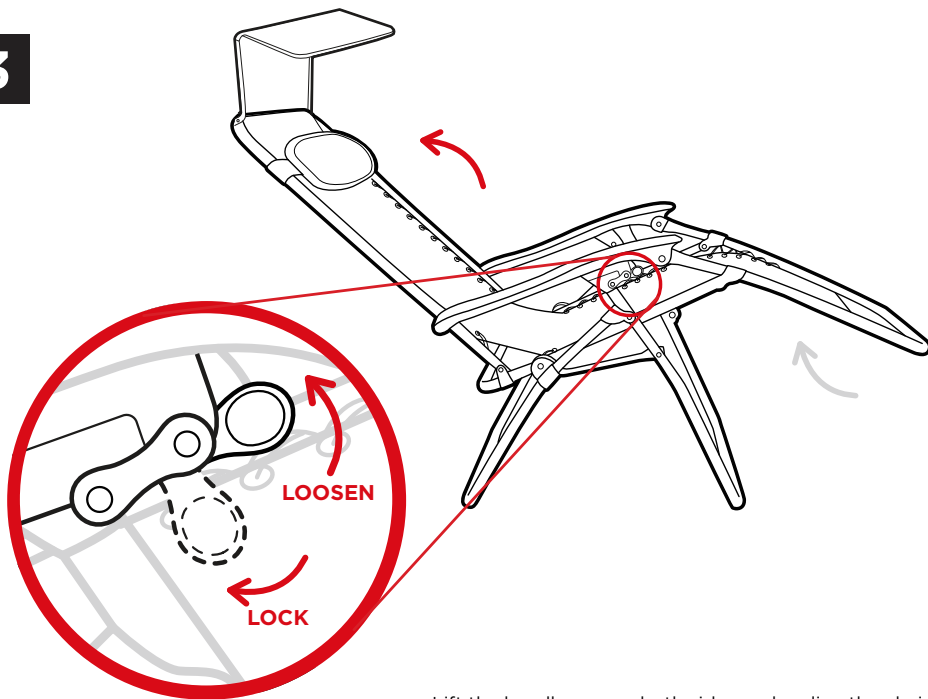

Lift the handles up on both sides and recline the chair.
Push the handles back to lock the chair at your desired position.

4

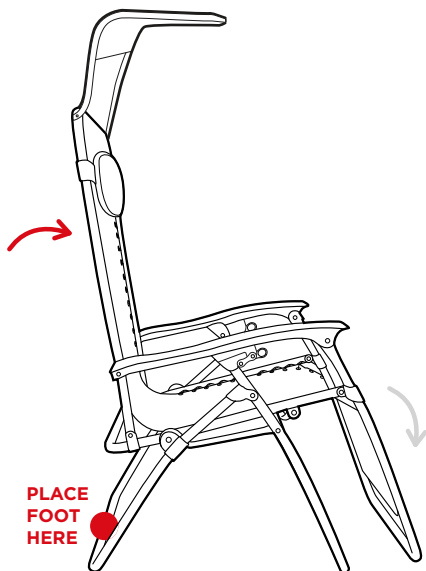

To return to an upright position, lift handles up,
place a foot on the back chair leg, and push the backrest upright.

PRODUCT ASSEMBLY

5

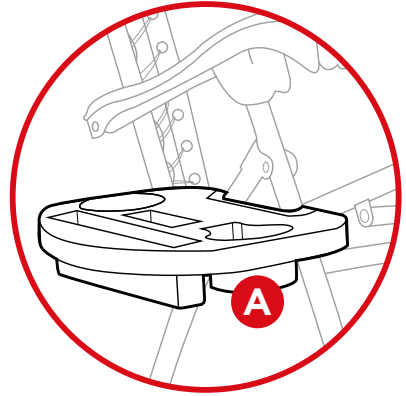
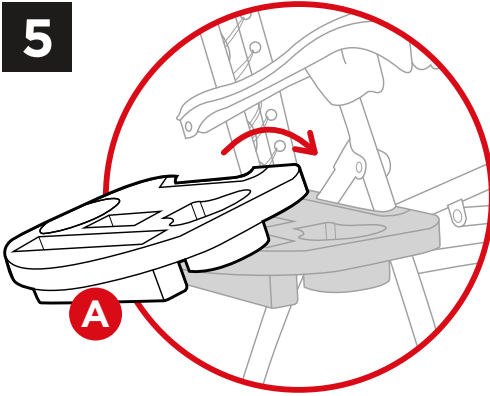

To install the accessory tray, slide the tray over the leg hinge and push down to lock it in place.

Note: remove the accessory tray before folding the chair.

PRODUCT WARRANTY INFORMATION

All items can be returned for any reason within 60 days of the receipt and will receive a full refund as long as the item is returned in its original product packaging and all accessories from its original shipment are included. All returned items will receive a full refund back to the original payment method. All returned items will not be charged a re-stocking fee.

All returned items require an RA (Return Authorization) number, which can only be provided by a Best Choice Products Customer Service Representative when the return request is submitted. Items received without an RA may not be accepted or may increase your return processing time. Once an item has been received by Best Choice Products, refunds or replacements will be processed within 5 business days.

All returns must be shipped back to the Best Choice Products Return Center at the customer's expense. If the reason for return is a result of an error by Best Choice Products then Best Choice Products will provide a pre-paid shipping label via email. Boxes for return shipping will not be provided by Best Choice Products, and is the customer's responsibility to either use the original shipping boxes or purchase new boxes.

Pictures may be required for some returns to ensure an item is not damaged prior to its return. Items returned are not considered undamaged until they are received by Best Choice Products and verified as such. All damages to items are the customer's responsibility until the item has been received by and acknowledge by Best Choice Products as undamaged.

CONTACT US; WE'RE HERE 7 DAYS A WEEK TO HELP YOU!



bestchoiceproducts.com



customerservice@bestchoiceproducts.com



844.948.8400



[LEARN MORE!](#)

WARNING

Manufacturer and seller expressly disclaim any and all liability for personal injury, property damage or loss, whether direct, indirect, or incidental, resulting from the incorrect attachment, improper use, inadequate maintenance, or neglect of this product.