

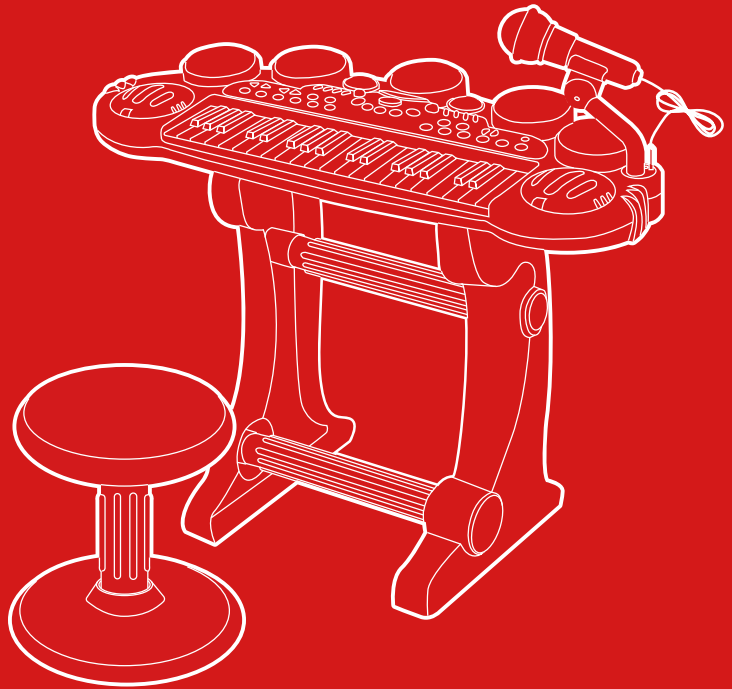

bestchoiceproducts



INSTRUCTION MANUAL

37-Key Kids Electronic Keyboard

REQUIRED



PHILLIPS
SCREWDRIVER



6 AA BATTERIES



1 PERSON
ASSEMBLY



APPROXIMATELY
10 MIN.
ASSEMBLY

PARTS

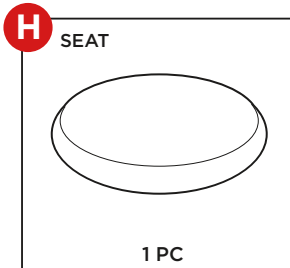
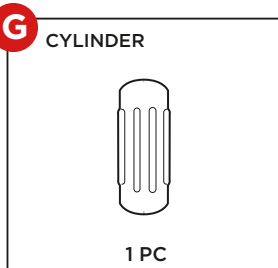
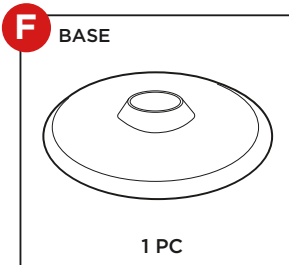
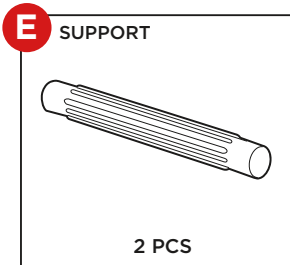
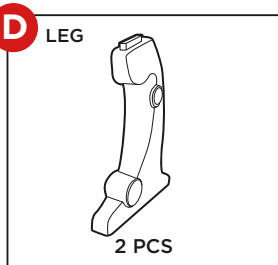
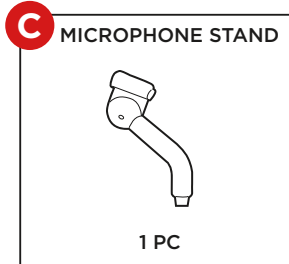
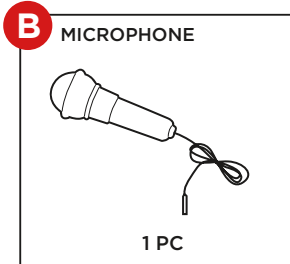
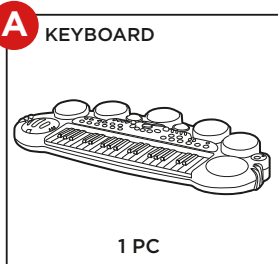

WARNING

- Do not disassemble or modify internal parts. If it malfunctions, discontinue use until repairs have been made.
- Do not play at maximum volume or at an uncomfortable level for an extended period of time.
- Overheating the product may cause damage; keep off all heat sources.
- Prevent liquid, dust, particles, and other foreign matter from entering the product because it may cause corrosion or short-circuit the components.
- To reduce risk of fire or electric shock, do not expose product to rain or humidity.
- Do not expose product to dripping or splashing liquid. Do not place objects filled with liquid on the product.
- Avoid exposure to direct sunlight and excessive heat.

PRODUCT ASSEMBLY

Please retain these instructions for future reference.

1

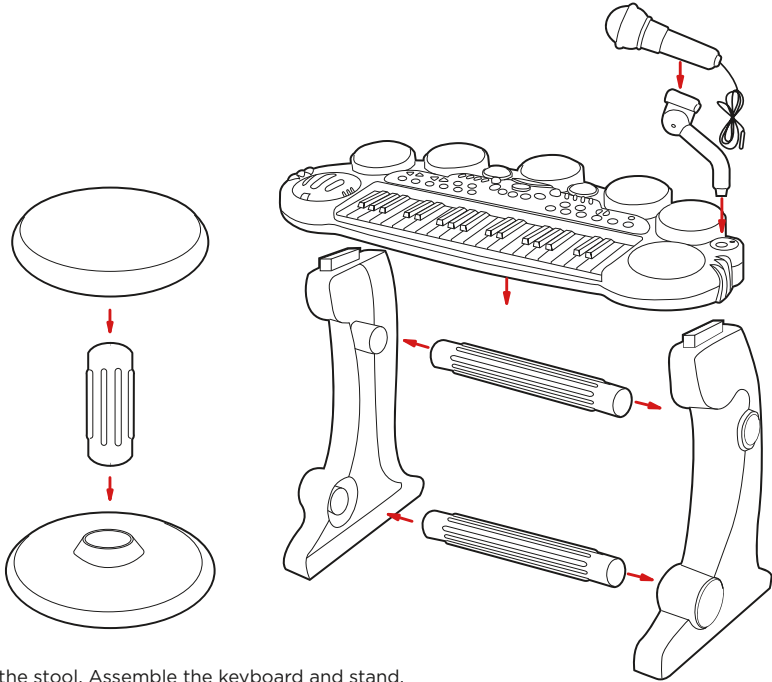

Assemble the stool. Assemble the keyboard and stand.

KEYBOARD DIAGRAM

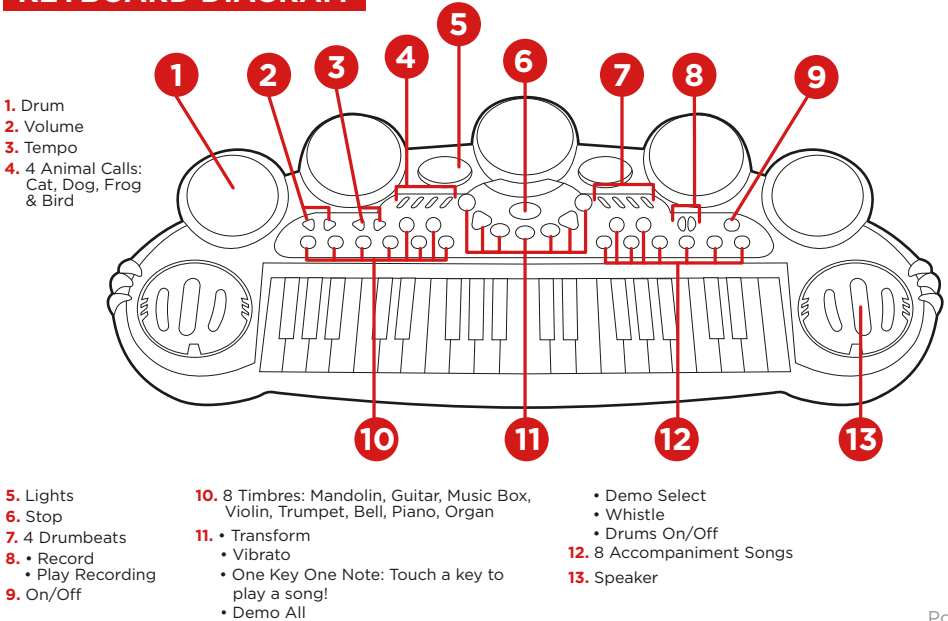

- 1. Drum
- 2. Volume
- 3. Tempo
- 4. 4 Animal Calls:
Cat, Dog, Frog
& Bird

- 5. Lights
- 6. Stop
- 7. 4 Drumbeats
- 8. • Record
• Play Recording
- 9. On/Off

- 10. 8 Timbres: Mandolin, Guitar, Music Box,
Violin, Trumpet, Bell, Piano, Organ
- 11. • Transform
• Vibrato
• One Key One Note: Touch a key to
play a song!
• Demo All

- Demo Select
- Whistle
- Drums On/Off
- 12. 8 Accompaniment Songs
- 13. Speaker

BATTERY INSTALLATION

- Use a screwdriver to remove the battery cover.
- Insert 6 AA batteries. Make sure the batteries are inserted with the correct polarity.
- Replace the battery cover.



WARNINGS REGARDING BATTERIES

- Do not mix alkaline, standard (carbon zinc) and rechargeable (nickel hydride) batteries.
- Do not mix old and new batteries.
- Non-rechargeable batteries should not be charged.
- Rechargeable batteries should be charged under adult supervision only.
- Exhausted batteries should be removed.
- The supply terminals should not be short-circuited.
- Do not put batteries next to or in a heat source (fire, electronic heating device, etc.).
- Do not hit batteries against hard objects.
- Do not submerge batteries in water.
- Batteries should be inserted with the correct polarity.

CARE AND MAINTENANCE

- If unused for a long period of time, remove the batteries.
- Use dry, soft cloth to clean the product. Do not use alcohol or other chemical solvents to wipe the product. Using these substances may damage the surface.

PRODUCT WARRANTY INFORMATION

All items can be returned for any reason within 60 days of the receipt and will receive a full refund as long as the item is returned in its original product packaging and all accessories from its original shipment are included. All returned items will receive a full refund back to the original payment method. All returned items will not be charged a re-stocking fee.

All returned items require an RA (Return Authorization) number, which can only be provided by a Best Choice Products Customer Service Representative when the return request is submitted. Items received without an RA may not be accepted or may increase your return processing time. Once an item has been received by Best Choice Products, refunds or replacements will be processed within 5 business days.

All returns must be shipped back to the Best Choice Products Return Center at the customer's expense. If the reason for return is a result of an error by Best Choice Products then Best Choice Products will provide a pre-paid shipping label via email. Boxes for return shipping will not be provided by Best Choice Products, and is the customer's responsibility to either use the original shipping boxes or purchase new boxes.

Pictures may be required for some returns to ensure an item is not damaged prior to its return. Items returned are not considered undamaged until they are received by Best Choice Products and verified as such. All damages to items are the customer's responsibility until the item has been received by and acknowledged by Best Choice Products as undamaged.

CONTACT US, WE'RE HERE 7 DAYS A WEEK TO HELP YOU!



bestchoiceproducts.com



customerservice@bestchoiceproducts.com



844.948.8400



[LEARN MORE!](#)

WARNING

Manufacturer and seller expressly disclaim any and all liability for personal injury, property damage or loss, whether direct, indirect, or incidental, resulting from the incorrect attachment, improper use, inadequate maintenance, or neglect of this product.