

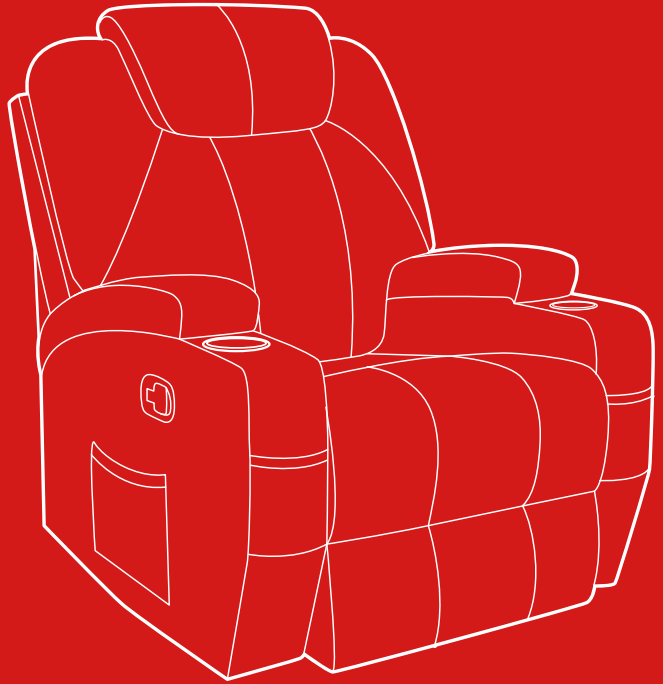

bestchoiceproducts



INSTRUCTION MANUAL

Massage Chair Recliner



bestchoiceproducts

Thank you for choosing us! Since 2002, Best Choice Products has been bringing customers high-quality products at the absolute lowest price. With everything ranging from instruments and toys to furniture and outdoor, we've got your everyday living essentials covered. We're centered around a customer-first philosophy – with free shipping, exceptional customer service, and a catalog sourced with you in mind.

NOTICE

Please retain these instructions for future reference.

- Firmly secure all parts before use.
- Reconfirm that all parts are secure every 90 days.
- Do not use or store this item or its parts in the proximity of open flame or flammable/combustible chemicals.
- Do not expose this chair or its electrical parts to water.
- If any parts are missing, broken, damaged, or worn, stop using this product until repairs are made and/or factory replacement parts are installed.
- Do not use this item in a way inconsistent with the manufacturer's instructions as this could void the product warranty.
- Do not exceed 250 lbs. when using this product. This chair is not designed for multiple people to sit at once.
- Do not let small children or pets near during assembly.

WARNINGS

- This massage chair features electrical components. Do not expose this massage chair to high temperatures or humidity.
- Always unplug this appliance when not in use.
- Only plug this product into a grounded outlet. Do not plug this product in with any electrical adaptor besides the included plug. Do not modify the plug in any way.
- Unattended children and individuals with impairments that may prevent them from safely operating this device should not use this chair.
- Do not stand on any part of the chair.
- Do not use this chair outdoors.
- Do not use this chair if massage mechanism is exposed.
- Do not use this chair if your physician or healthcare professional has advised against massage chair use.
- Do not use this chair if you are inebriated, have a pacemaker, heart condition, skin condition or injury, are pregnant, plan on becoming pregnant, have just given birth, have a disease like diabetes that disrupts sensory feedback, have osteoporosis, chronic pain or injuries, have a fever, or have other medical issues that may impede your ability to safely use this chair.
- Do not use this chair for sleeping, or if you have a history of narcolepsy.
- If you experience any pain, illness, or discomfort during use, discontinue using this chair and consult with a physician.
- Do not use massage chair at the same time as other medical or therapeutic devices, such as blanket warmer or another massage device.
- Only operate this device on a stable, flat surface.
- Do not operate massage function or heating function for long periods of time.
- Do not pull out the plug to turn off this massage chair. Turn off all functions before unplugging the chair.



250 LBS
CAPACITY



2 PERSON
ASSEMBLY



APPROXIMATELY
30 MIN.
ASSEMBLY

PARTS

A

BACKREST

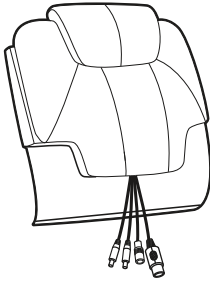

1 PC

B

SEAT

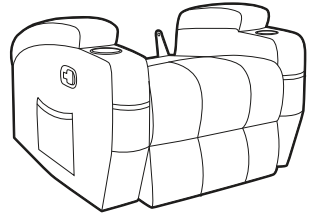

1 PC

C

WALL ADAPTOR PLUG

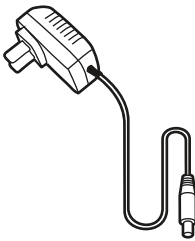

1 PC

D

REMOTE

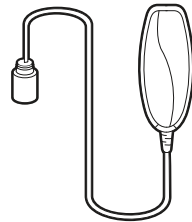

1 PC

ASSEMBLY

1

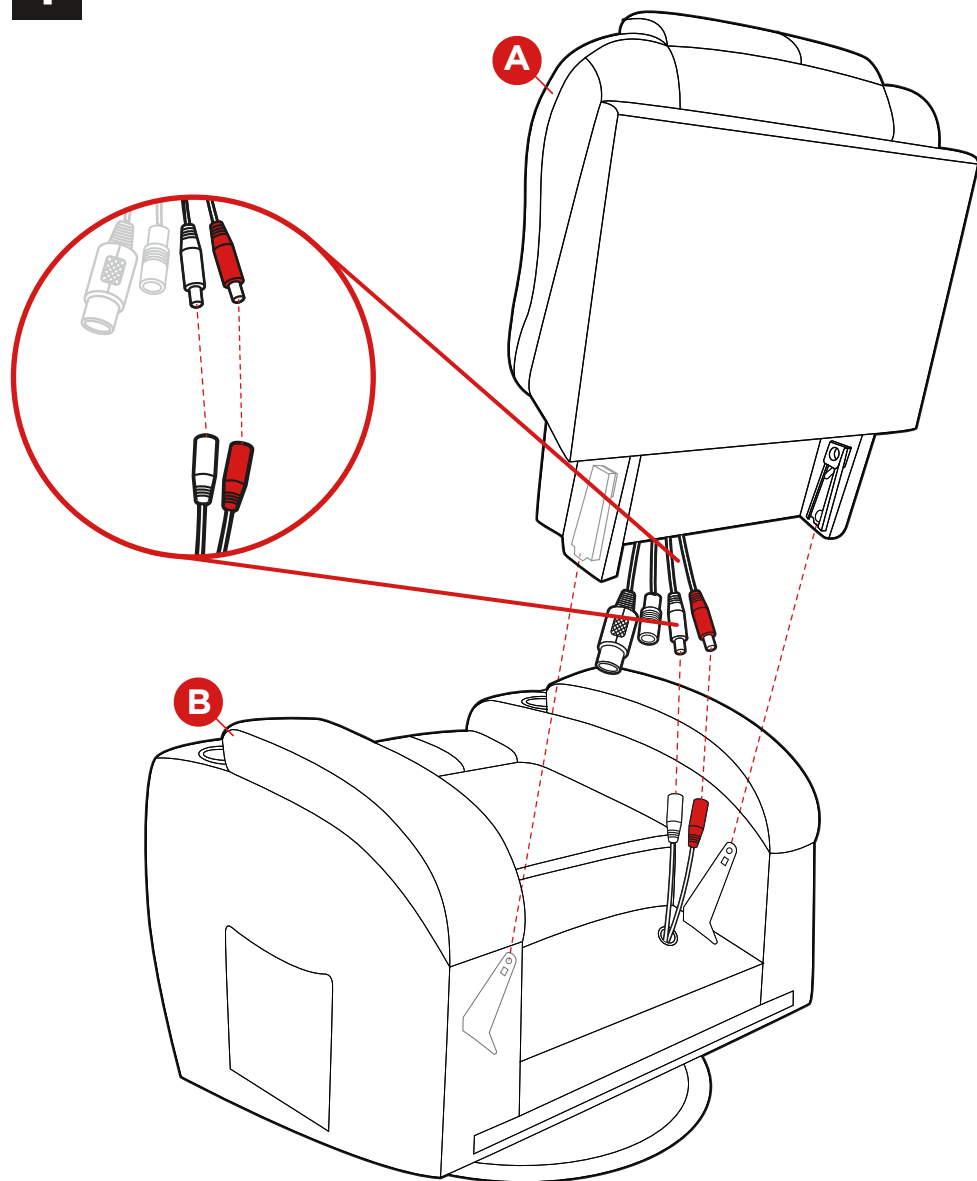

Insert part A backrest into part B seat, ensuring the two metal inserts on the seat slide into the clips on the backrest with a click. Join the wires from the backrest to the corresponding wires on the seat. Make sure that the corresponding sizes and colors match.

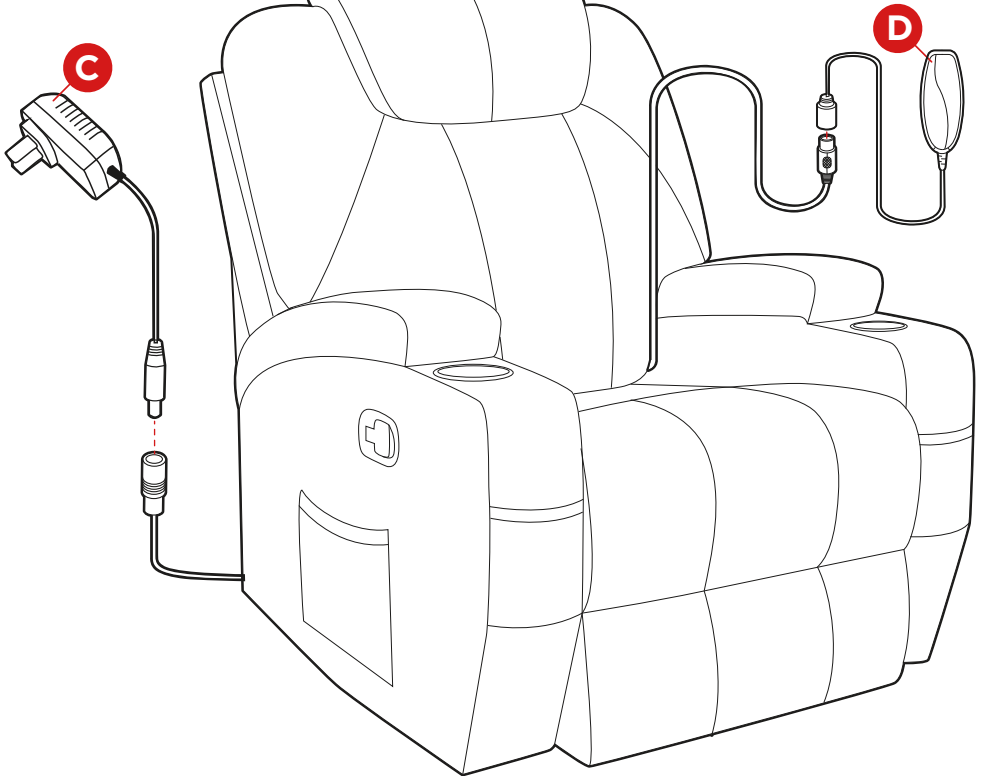

Join the part C wall adaptor plug and part D remote to the appropriate wires.

USE

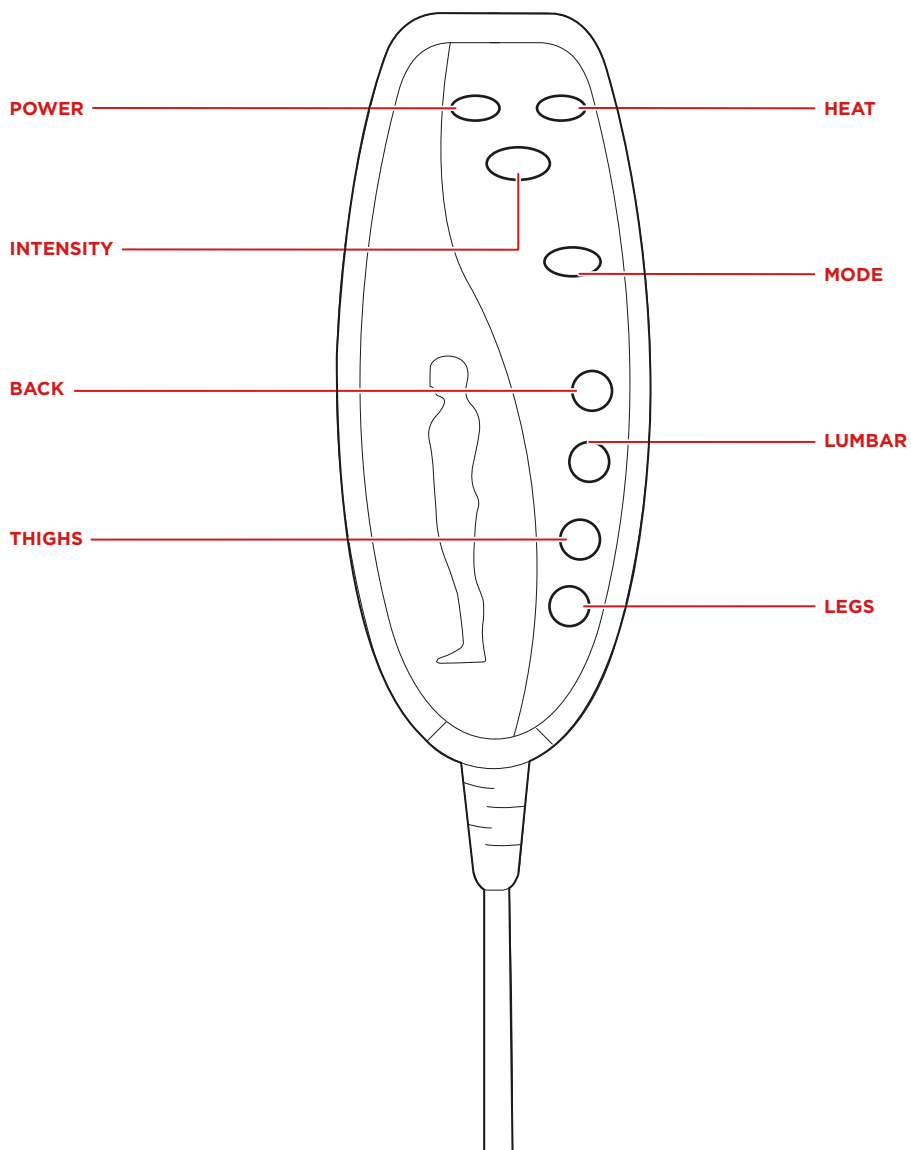

INTENSITY: Switch between a high and low intensity massage.

MODE: Select different types of massages, such as PULSE, PRESS, or WAVE. This also controls the AUTO and NORMAL functions. Press this button to cycle through options.

BACK, LUMBAR, THIGHS, and LEGS: Target massages to specific areas or turn off massage functions for specific areas.

ENJOY YOUR PRODUCT!

bcp

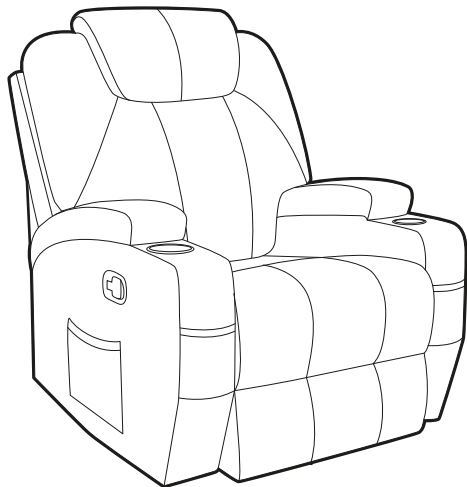

PRODUCT WARRANTY INFORMATION

All items can be returned for any reason within 60 days of the receipt and will receive a full refund as long as the item is returned in its original product packaging and all accessories from its original shipment are included. All returned items will receive a full refund back to the original payment method. All returned items will not be charged a re-stocking fee.

All returned items require an RA (Return Authorization) number, which can only be provided by a Best Choice Products Customer Service Representative when the return request is submitted. Items received without an RA may not be accepted or may increase your return processing time. Once an item has been received by Best Choice Products, refunds or replacements will be processed within 5 business days.

All returns must be shipped back to the Best Choice Products Return Center at the customer's expense. If the reason for return is a result of an error by Best Choice Products then Best Choice Products will provide a pre-paid shipping label via email. Boxes for return shipping will not be provided by Best Choice Products, and is the customer's responsibility to either use the original shipping boxes or purchase new boxes.

Pictures may be required for some returns to ensure an item is not damaged prior to its return. Items returned are not considered undamaged until they are received by Best Choice Products and verified as such. All damages to items are the customer's responsibility until the item has been received by and acknowledge by Best Choice Products as undamaged.

CONTACT US; WE'RE HERE 7 DAYS A WEEK TO HELP YOU!



bestchoiceproducts.com



customerservice@bestchoiceproducts.com



844.948.8400



LEARN MORE!

⚠️ WARNING

Manufacturer and seller expressly disclaim any and all liability for personal injury, property damage or loss, whether direct, indirect, or incidental, resulting from the incorrect attachment, improper use, inadequate maintenance, or neglect of this product.