

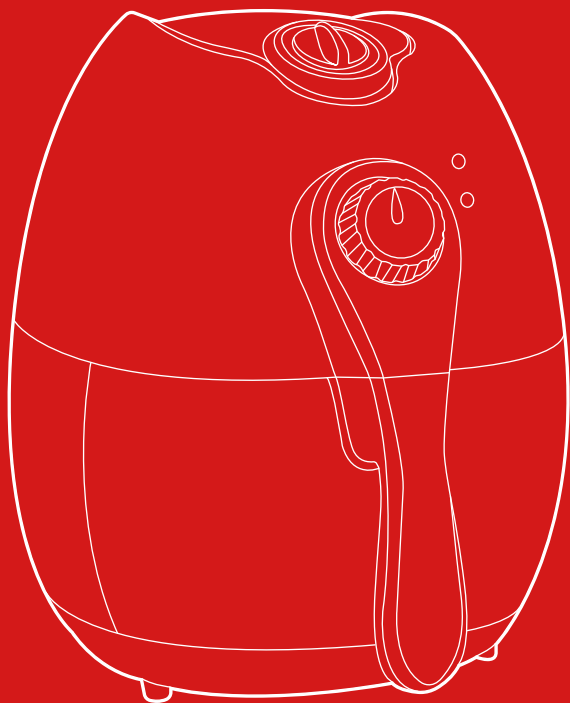

bestchoiceproducts



INSTRUCTION MANUAL

4.4-Quart Air Fryer



bestchoiceproducts

Thank you for choosing us! Since 2002, Best Choice Products has been bringing customers high-quality products at the absolute lowest price. With everything ranging from instruments and toys to furniture and outdoor, we've got your everyday living essentials covered. We're centered around a customer-first philosophy – with free shipping, exceptional customer service, and a catalog sourced with you in mind.

SAFETY TIPS

Please retain these instructions for future reference.

- In order to avoid damage or injury, make sure to follow all safety instructions and warnings.
- Unattended children and individuals with impairments that may prevent them from safely operating this air fryer should not use this appliance.
- **DO NOT** operate this appliance if you have a pacemaker, hearing aids, or similar medical devices. Please consult a professional licensed physician before operating this appliance.
- Children should not be allowed to play with this appliance.

WARNINGS

- Improper usage or handling may result in damage to property or person.
- Do not place this appliance on or near combustible materials such as tablecloth, curtains, etc.
- Do not touch or place yourself near the air outlet vent of this appliance when it is working.
- Do not cover the air inlet or outlet when appliance is working.
- Do not repair the appliance. Any repairs should be conducted by an authorized professional.
- Do not use the appliance outside the proper voltage (AC 220V).
- Do not use the appliance if there is damage to the plug, main cord, or appliance.
- Do not expose plug or cord to high temperatures during operation.
- If cord becomes hot, stop operation of this appliance.
- Do not pull out the plug if hands are wet.
- Do not move or shake the appliance during operation.
- Do not place metal or other conductive material into vent bottom of appliance or you could risk electric shock.
- Do not immerse this appliance in water, rinse under tap, or keep in wet/humid areas (this does not refer to the removable basket).
- Do not position cord near air vents while appliance is in operation.
- Do not keep power cord plugged in when appliance is not in use.
- Do not operate this appliance with an external timer or remote-control system.
- Do not place flammable items such as paper or plastic into the fryer.
- Do not operate unless plug is properly plugged into a wall socket.
- Do not turn on appliance unless frying drawer is inserted correctly and fully.
- Do not use this product if you notice any problems during operation.
- Do not fill fryer with oil or other frying ingredients. This appliance uses hot air circulation
- This appliance requires an outlet with a separated security current over 10A. Do not share an outlet with other appliances or risk damaging the outlet or causing a fire.
- Clean the power cord plug or socket if there is dust or water. Do not plug power cord in if wet or if there are dust particles on the socket or cord.
- Leave about 20 centimeters (8 inches) of clearance around the appliance during operation. Never cover the appliance with other items.
- This appliance is designed for household use only.
- After finishing operation of this appliance, make sure the appliance timer is set to "0" and the appliance is unplugged.

SPECIFICATIONS

Model No.	Power Specifications	Rated Power	Mesh Basket Capacity	Fryer Pan Capacity
SKY2765 SKY2766 SKY3075	120V 60Hz	1300W	2.7L	4.2L

DIAGRAM

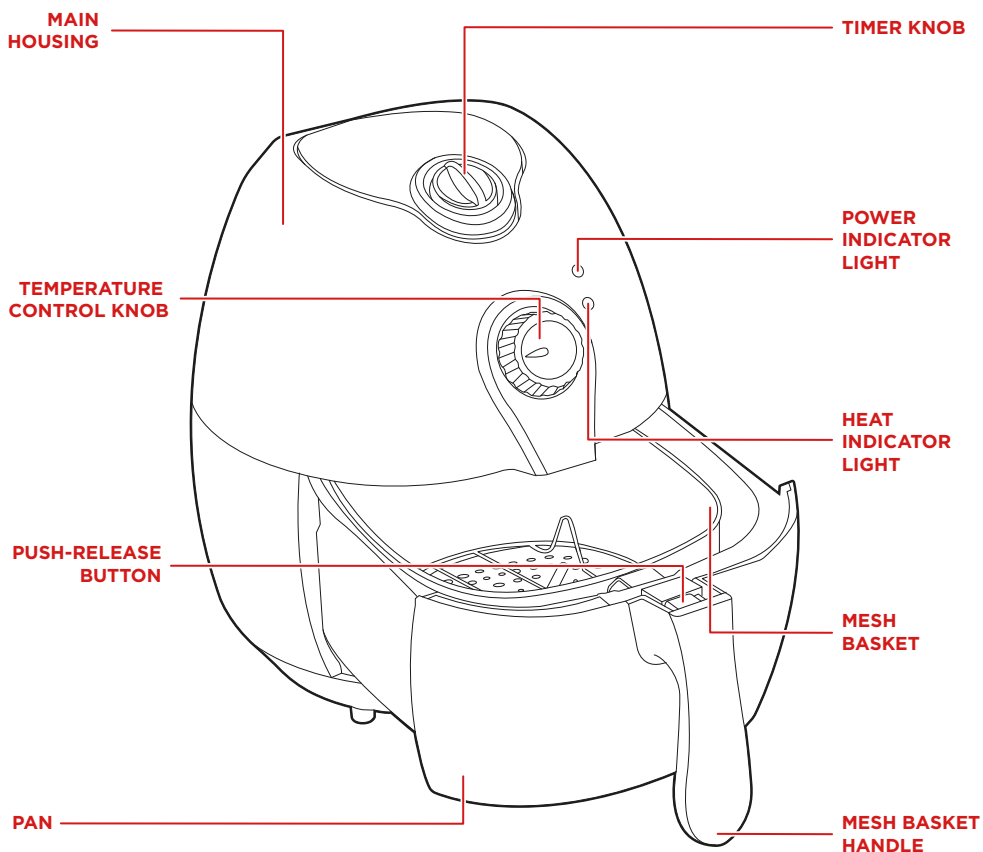

TIMER KNOB: The maximum timer setting is 30 minutes.

TEMPERATURE CONTROL KNOB: The temperature can be set anywhere from 176°F to 392°F.

PREPARATION

1

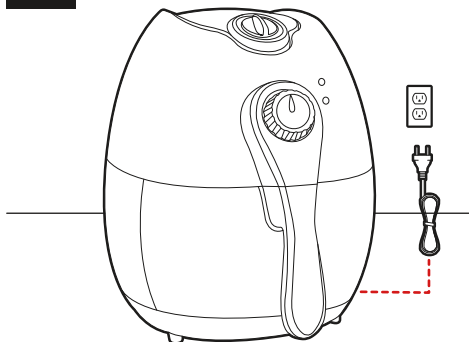

Place the appliance on a stable, horizontal flat surface and plug it into a wall outlet.

- Make sure power cord has enough length to reach the socket comfortably.
- Make sure appliance is placed in a well-ventilated area away from hot surfaces and combustible materials, and that the cord does not run in front of air outlet.

2

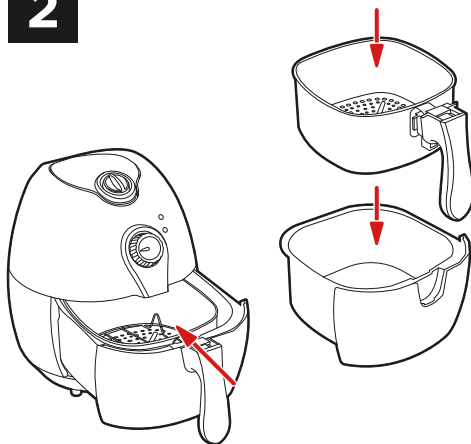

Place mesh basket into pan and it will lock into place. Insert the pan/mesh basket into air fryer chamber.

3

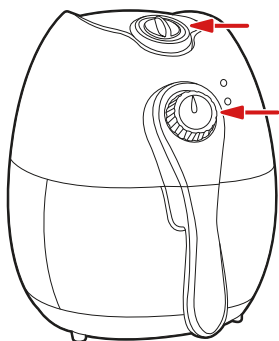

Preheat the appliance for **3 minutes** before placing ingredients into the basket.

Before **FIRST** use only, preheat the appliance for **10 minutes**.

FRYING

1

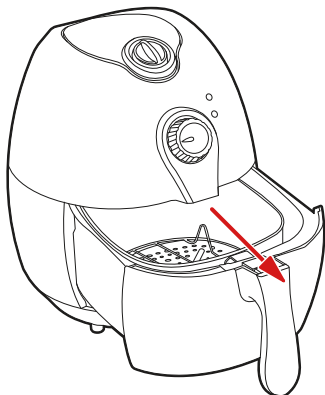

Carefully pull the pan out of the air fryer and place it on a stable, flat surface.

2

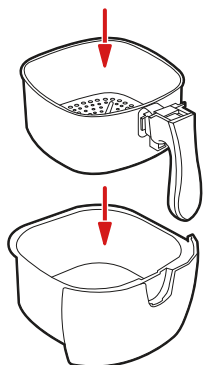

Place ingredients in the mesh basket. Make sure the basket is well-inserted into the pan.

NOTE: Do not fill past the MAX line.

3

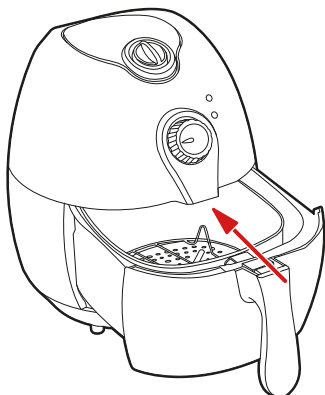

Slide pan back into air fryer and make sure it is securely in place.

FRYING

4

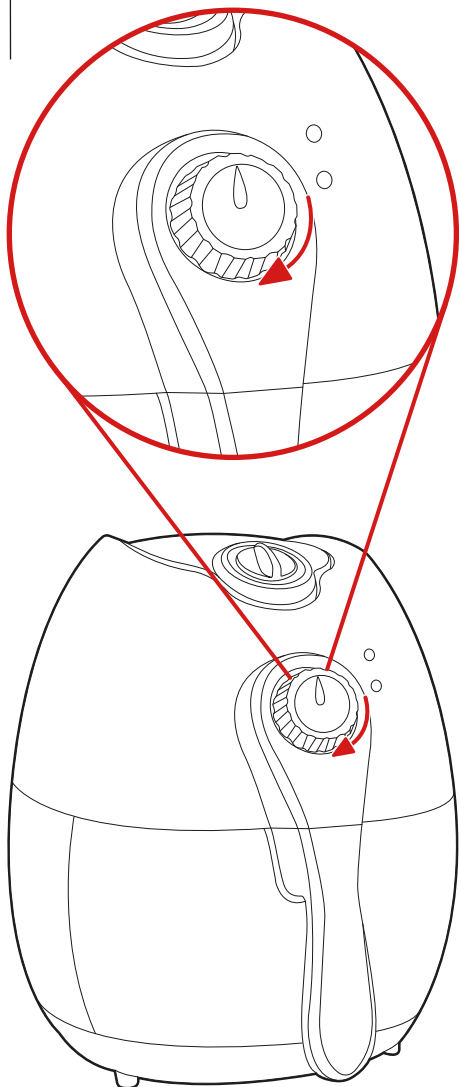

Turn the temperature control knob to desired temperature.

5

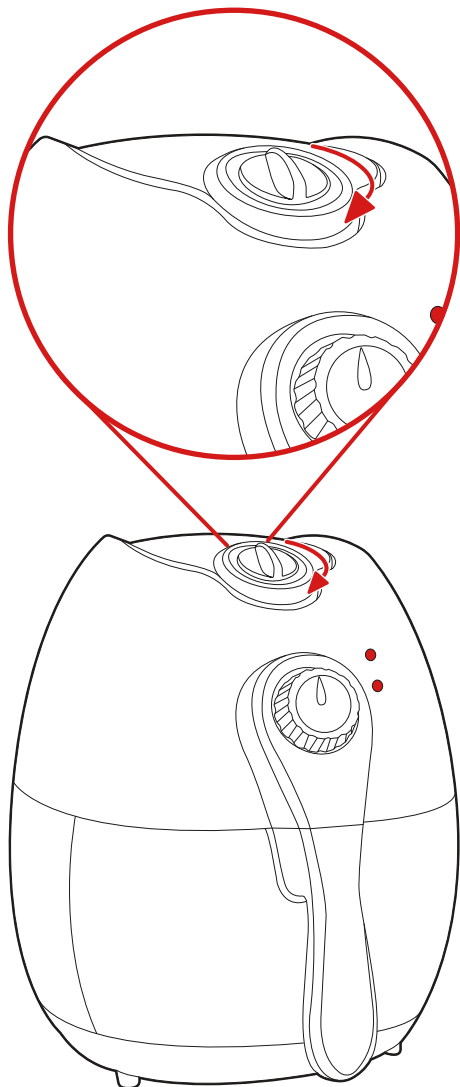

Turn the timer knob to the desired cook time. The power light will turn on to indicate the unit is working.

FRYING

6

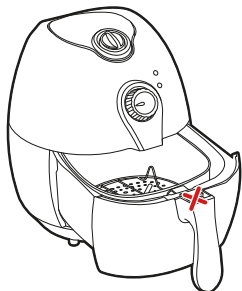

To prevent uneven cooking, you may wish to shake food in fryer by pulling out the pan, lightly shaking, and pushing the pan back in.

- Do not press the button to release the basket if you do this.

7

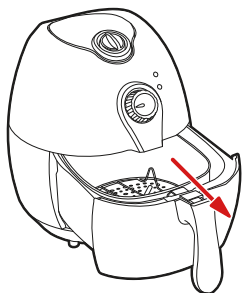

When cooking is finished, a bell on the appliance will chime. Carefully pull out the pan.

NOTE: Make sure to place the basket on a stable surface away from any combustible items.

8

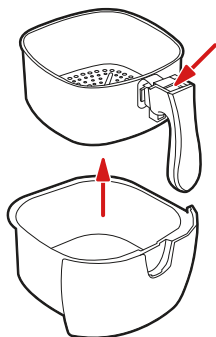

Press the button to release the basket.

Always unplug the appliance when you are done cooking with it. Do not move or store the appliance until it has completely cooled down.

USAGE NOTES

- Shaking foods placed in the air fryer during cooking can help prevent uneven cooking.
- Do not cook overly greasy foods in the air fryer.
- You can use a light amount of oil to make food crispy, but do not add an excessive amount of oil.
- Please use a baking tin or oven dish inside the basket if you wish to bake cakes, quiche or stuffed/fragile ingredients.

SUGGESTED COOKING SETTINGS FOR FOOD

For fun recipes, go to this air fryer's product page at bestchoiceproducts.com!

	Min-Max Amount (g)	Time (min.)	Temperature (°F)	Shake	Additional Information
Potatoes and Fries					
Thin Frozen Fries	300-700	9-16	392	Yes	Add .5 tsp oil, if desired
Thin Frozen Fries	300-700	11-20	392	Yes	Add .5 tsp oil, if desired
Home-Made Fries (8x8mm)	300-800	10-16	392	Yes	Add .5 tsp oil, if desired
Home-Made Potato Wedges	300-800	18-22	356	Yes	
Home-Made Potato Cubes	300-750	12-18	356	Yes	
Hash Browns/Rösti	250	15-18	356	Yes	
Potato Gratin	500	15-18	392	Yes	
Meat and Poultry					
Steak	100-500	8-12	356		
Pork Chops	100-500	10-14	356		
Hamburger	100-500	7-14	356		
Sausage Roll	100-500	13-15	392		
Drumsticks	100-500	18-22	356		
Chicken Breast	100-500	10-15	356		
Snacks					
Spring Rolls	100-400	8-10	392	Yes	Use Oven-Ready Item
Frozen Chicken Nugget	100-500	6-10	392	Yes	Use Oven-Ready Item
Frozen Fish Fingers	100-400	6-10	392		Use Oven-Ready Item
Frozen Mozzarella Sticks	100-400	8-10	356		Use Oven-Ready Item
Stuffed Vegetable	100-400	10	320		

CLEANING AND MAINTENANCE

- Always clean the air fryer after it has cooled down completely.
- Unplug the air fryer before cleaning.
- Do not use a strong, corrosive cleaner to clean this appliance.
- Use a soft, clean cloth to wipe down air fryer. Do not use a wet cloth.
- Do not clean the pan, basket, and inside of appliance with metal kitchen utensils or abrasive cleaning materials or you could damage the protective coating.
- Clean pan, separator, and basket with normal water, some dish washing liquid, and a non-abrasive sponge. Pan and basket are also dishwasher safe.

TROUBLESHOOTING

Problem	Reason	Solution
Air fryer does not work	Appliance is not plugged in correctly	Plug into grounded wall outlet
	Timer/mode is not set	Set timer to start the air fryer
	Pan is not well-inserted	Pull pan out and re-insert
Ingredients fried by fryer are not done	Too many ingredients in basket	Place smaller batches in fryer; smaller batches cook quicker and more even
	Set temperature is too low	Raise temperature
Ingredients are fried unevenly	Large batches of ingredients and ingredients that lay on top of each other can cook uneven	Certain ingredients should be shaken halfway through cooking
	Ingredients are not fresh or prepared properly	Make sure to use fresh ingredients, and prepare them correctly for frying (such as rinsing potatoes of starch)
Fried snacks are not crispy when they come out of the fryer	Certain ingredients are better for air frying	Lightly brush some oil onto snacks or use oven-ready snacks in air fryer
Pan will not slide into air fryer correctly	Too many ingredients in basket	Do not fill basket beyond MAX indication
	Basket not placed into pan correctly	Push basket into pan until it makes a click
White smoke comes out of appliance	Food in air fryer is greasy	White smoke is normal when frying greasy food in air fryer and should be OK
	Pan still contains grease residue from previous use	Make sure you properly clean the pan after each use

ENJOY YOUR PRODUCT!

bcp

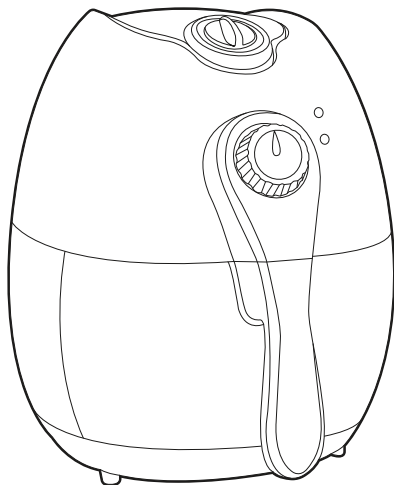

PRODUCT WARRANTY INFORMATION

All items can be returned for any reason within 60 days of the receipt and will receive a full refund as long as the item is returned in its original product packaging and all accessories from its original shipment are included. All returned items will receive a full refund back to the original payment method. All returned items will not be charged a re-stocking fee.

All returned items require an RA (Return Authorization) number, which can only be provided by a Best Choice Products Customer Service Representative when the return request is submitted. Items received without an RA may not be accepted or may increase your return processing time. Once an item has been received by Best Choice Products, refunds or replacements will be processed within 5 business days.

All returns must be shipped back to the Best Choice Products Return Center at the customer's expense. If the reason for return is a result of an error by Best Choice Products then Best Choice Products will provide a pre-paid shipping label via email. Boxes for return shipping will not be provided by Best Choice Products, and is the customer's responsibility to either use the original shipping boxes or purchase new boxes.

Pictures may be required for some returns to ensure an item is not damaged prior to its return. Items returned are not considered undamaged until they are received by Best Choice Products and verified as such. All damages to items are the customer's responsibility until the item has been received by and acknowledge by Best Choice Products as undamaged.

CONTACT US; WE'RE HERE 7 DAYS A WEEK TO HELP YOU!



bestchoiceproducts.com



customerservice@bestchoiceproducts.com



844.948.8400



[LEARN MORE!](#)

⚠️ WARNING

Manufacturer and seller expressly disclaim any and all liability for personal injury, property damage or loss, whether direct, indirect, or incidental, resulting from the incorrect attachment, improper use, inadequate maintenance, or neglect of this product.